

aquatica®

Function : Form : Fashion



Bollicine-D-121
2-Hole Deck Mounted Bath Filler

Installation & Care Manual
Europe / International

Bollicine-D-121

2-Hole Deck Mounted Bath Filler

PARTS LIST

 MEASUREMENTS: mm

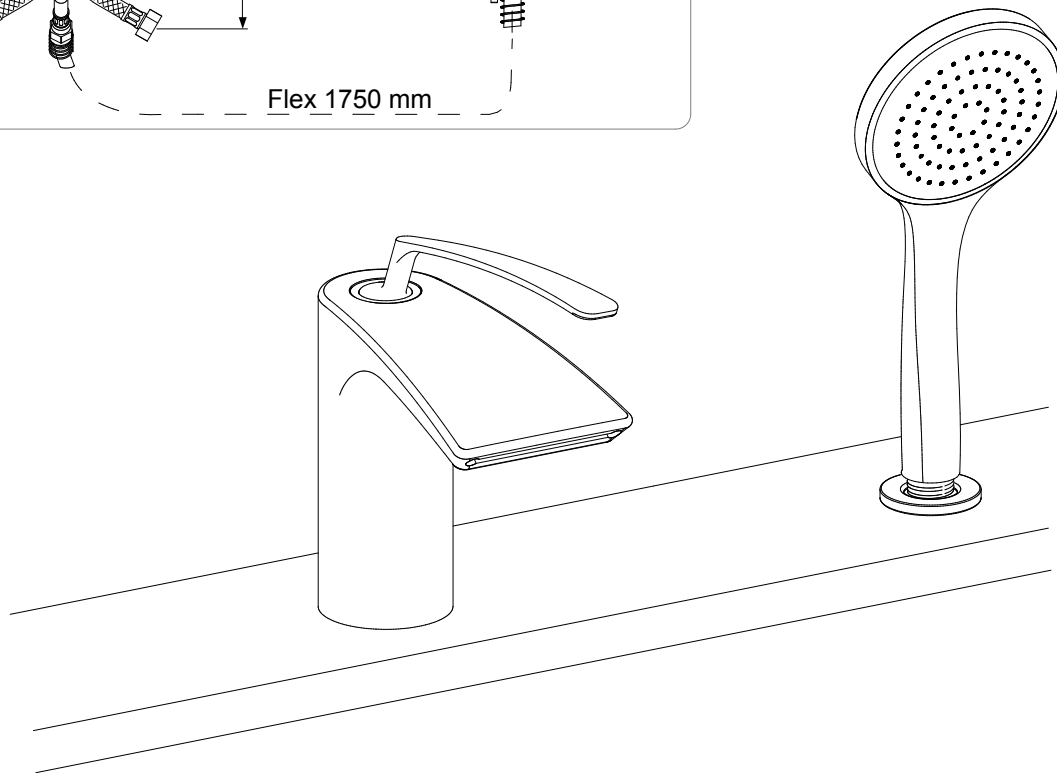
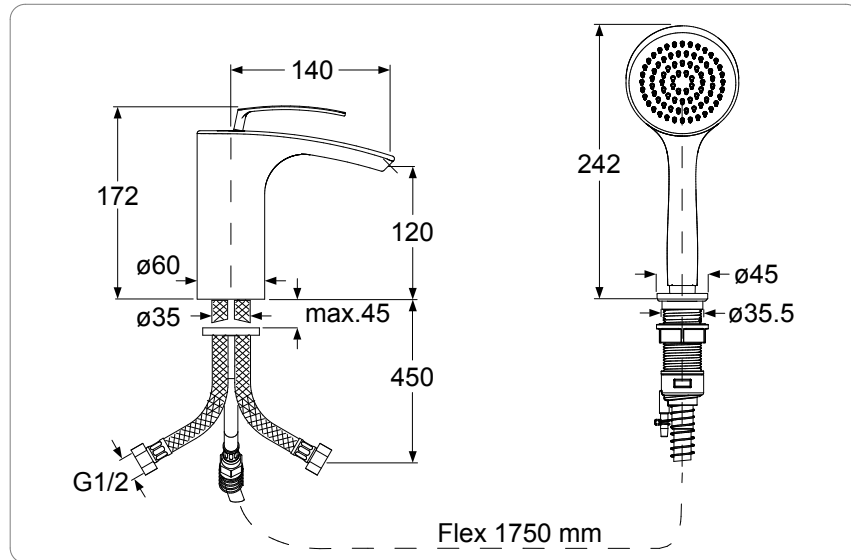

SPECIFICATIONS

Recommended operational pressure	1-5 bar
Maximum test pressure	16 bar
Maximum hot water temperature	80 °C
Recommended temperature	50-60 °C
Pressure difference between hot and cold water	max. 1,5 bar

IMPORTANT NOTE

- Installation to be performed by qualified personnel
- Before connecting to mains, bleed the pipes to avoid damage.



Bollicine-D-121

2-Hole Deck Mounted Bath Filler

INSTALLATION SEQUENCE

aquatica®

Function : Form : Fashion

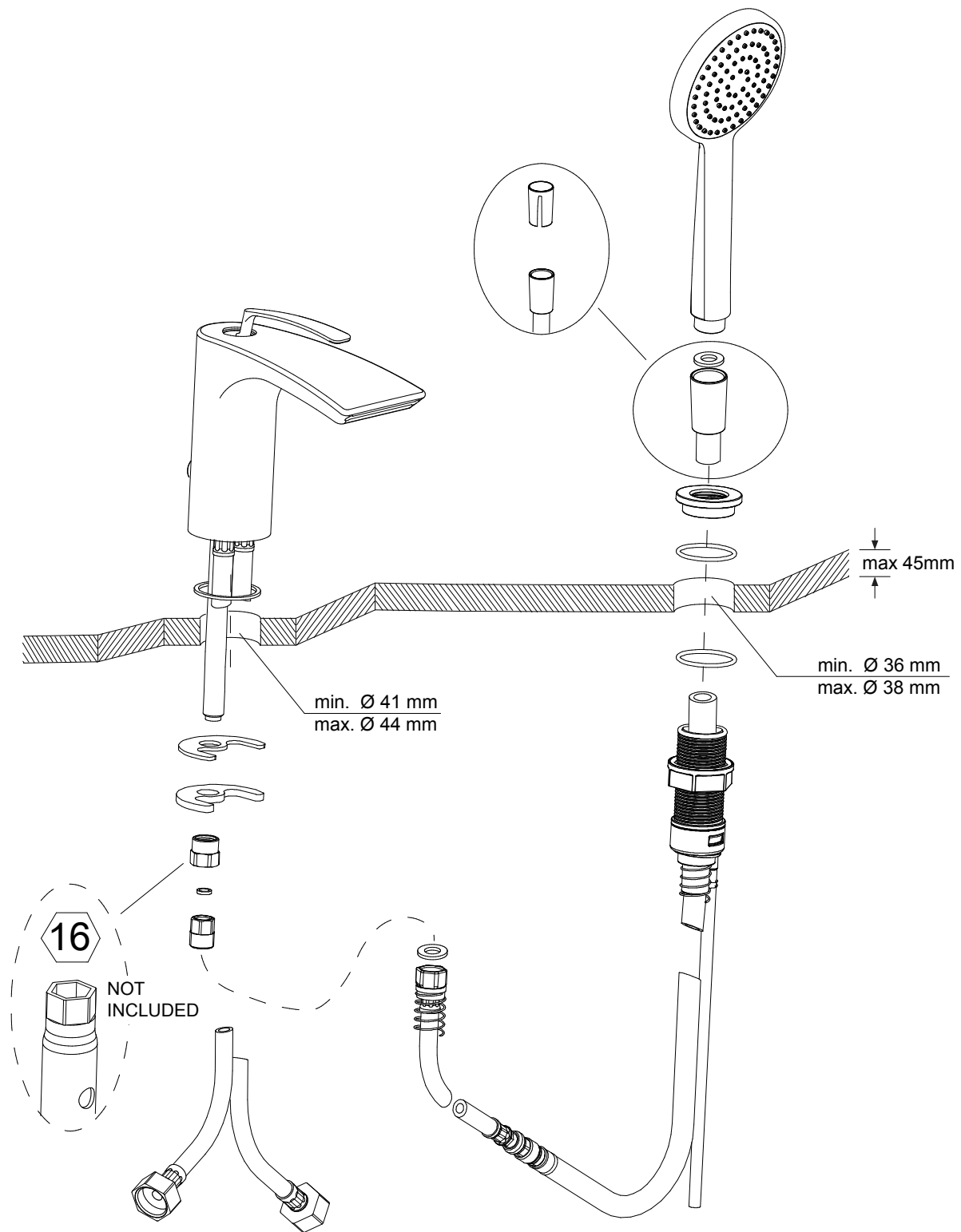

aquatica®

Function : Form : Fashion

aquatica®

Function : Form : Fashion

